

**1204M / 1205M Manual**

---

# MANUAL

---

---

**MODELS**  
**1204M**  
**1205M**

**MOTOR CONTROLLERS**

© 2011 CURTIS INSTRUMENTS, INC.

1204M/1205M Manual, p/n 53113  
Rev. B: February 2011



**CURTIS INSTRUMENTS, INC.**

200 Kisco Avenue  
Mt. Kisco, New York 10549 USA  
Tel. 914.666.2971  
Fax 914.666.2188

[www.curtisinstruments.com](http://www.curtisinstruments.com)



<b>CONTENTS</b>	
1. OVERVIEW .....	1
2. INSTALLATION AND WIRING .....	3
Mounting the Controller .....	3
Connections: High Current .....	5
Connections: Low Current .....	5
Controller Wiring: Basic Configuration.....	7
KSI Wiring .....	7
Forward/Reverse Wiring.....	8
Throttle Wiring .....	9
Wiring Configuration for Pump Applications .....	12
Installation Checkout .....	13
3. PROGRAMMABLE PARAMETERS.....	15
Basic Parameters .....	16
Speed and Acceleration Parameters .....	17
Throttle Input Parameters .....	18
Undervoltage Parameters .....	20
Other Parameters.....	21
4. MONITOR MENU.....	22
5. DIAGNOSTICS AND TROUBLESHOOTING .....	23
6. MAINTENANCE .....	26
<b>APPENDIX A</b> EMC & ESD Design Considerations	
<b>APPENDIX B</b> Curtis WEEE & RoHS Statement	
<b>APPENDIX C</b> Programming Devices	
<b>APPENDIX D</b> 1204M / 1205M Controller Specifications	

## FIGURES

FIG. 1:	Curtis 1204M and 1205M electronic motor controllers.....	1
FIG. 2:	Mounting dimensions, Curtis 1204M/05M controller .....	3
FIG. 3:	Standard wiring configuration .....	7
FIG. 4:	Wiring to inhibit plug braking .....	8
FIG. 5:	Wiring for mechanical reversing .....	9
FIG. 6:	Wiring for Type 0 throttles .....	9
FIG. 7:	Wiring for Type 1 throttles .....	10
FIG. 8:	Wiring for Type 2 throttles .....	11
FIG. 9:	Wiring configuration for pump applications .....	12
FIG. 10:	Effect of throttle adjustment parameters.....	19

## TABLES

TABLE 1:	High current connections.....	5
TABLE 2:	Low current connections .....	5
TABLE 3:	J4 connector pinout .....	6
TABLE 4:	Status LED fault codes .....	23
TABLE 5:	Troubleshooting chart .....	25
TABLE D-1:	Specifications, 1204M / 1205M controllers .....	D-1

## 1

## OVERVIEW

Curtis 1204M and 1205M programmable series motor controllers are designed to provide smooth, silent, cost-effective control of motor speed and torque. They are updated versions of the popular 1204 and 1205 controllers, with the added functionality of being programmable—via a Curtis handheld programmer or PC programming station. This means the controllers can be tailored to the needs of specific applications. In addition to configuration flexibility, use of the programmer offers diagnostic and test capability.

Curtis 1204M and 1205M controllers are the ideal solution for a variety of electric vehicle applications, including industrial trucks, personnel carriers, material handling vehicles, golf cars, etc.

**Fig. 1** Curtis 1204M and 1205M programmable series motor controllers.

*Both are available with and without the A2 busbar.*

*Models without the A2 busbar can be used for pump operation or for drive applications where plug braking is not desired.*



Like all Curtis controllers, the 1204M and 1205M offer superior operator control of motor drive performance. **Features include:**

- ✓ High-frequency switching and ultra-low voltage drops provide high efficiency and silent operation.
- ✓ Simple mounting and wiring with push-on connectors for control signals and plated solid copper buses for power connections.
- ✓ Compatible with either a two-wire potentiometer or a voltage throttle.
- ✓ Throttle fault protection circuitry disables controller if throttle wires become open.
- ✓ High pedal disable feature prevents controller operation if key is turned on while throttle is applied.
- ✓ Plug braking diode internal to controller.
- ✓ Thermal protection and compensation circuit provides constant current limit over operating range and during under/over temperature cutback; no sudden loss of power under any thermal conditions.

*More Features* 

- ✓ Undervoltage cutback function protects against low battery voltage, including low voltage caused by external loads.
- ✓ Easily programmable through a Curtis programming device.
- ✓ Rugged anodized aluminum extruded housing meets IP65 environmental sealing standards for use in harsh environments.

Familiarity with your Curtis 1204M/05M controller will help you install and operate it properly. We encourage you to read this manual carefully. If you have questions, please contact the Curtis office nearest you.

## 2

## INSTALLATION AND WIRING

## MOUNTING THE CONTROLLER

The outline and mounting hole dimensions for the 1204M and 1205M controllers are shown in Figure 2. The controller meets the IP65 requirements for environmental protection against dust and water. Nevertheless, in order to prevent external corrosion and leakage paths from developing, **the mounting location should be carefully chosen to keep the controller as clean and dry as possible.**

It is recommended that the controller be fastened to a clean, flat metal surface with four M6 bolts, using the holes provided. The mounting surface is an integral part of the overall heatsinking of the controller, and affects its ability to dissipate heat. Although not usually necessary, a thermal joint compound can be used to improve heat conduction from the controller heatsink to the mounting surface.

**Fig. 2** *Mounting dimensions, Curtis 1204M and 1205M motor controllers.*

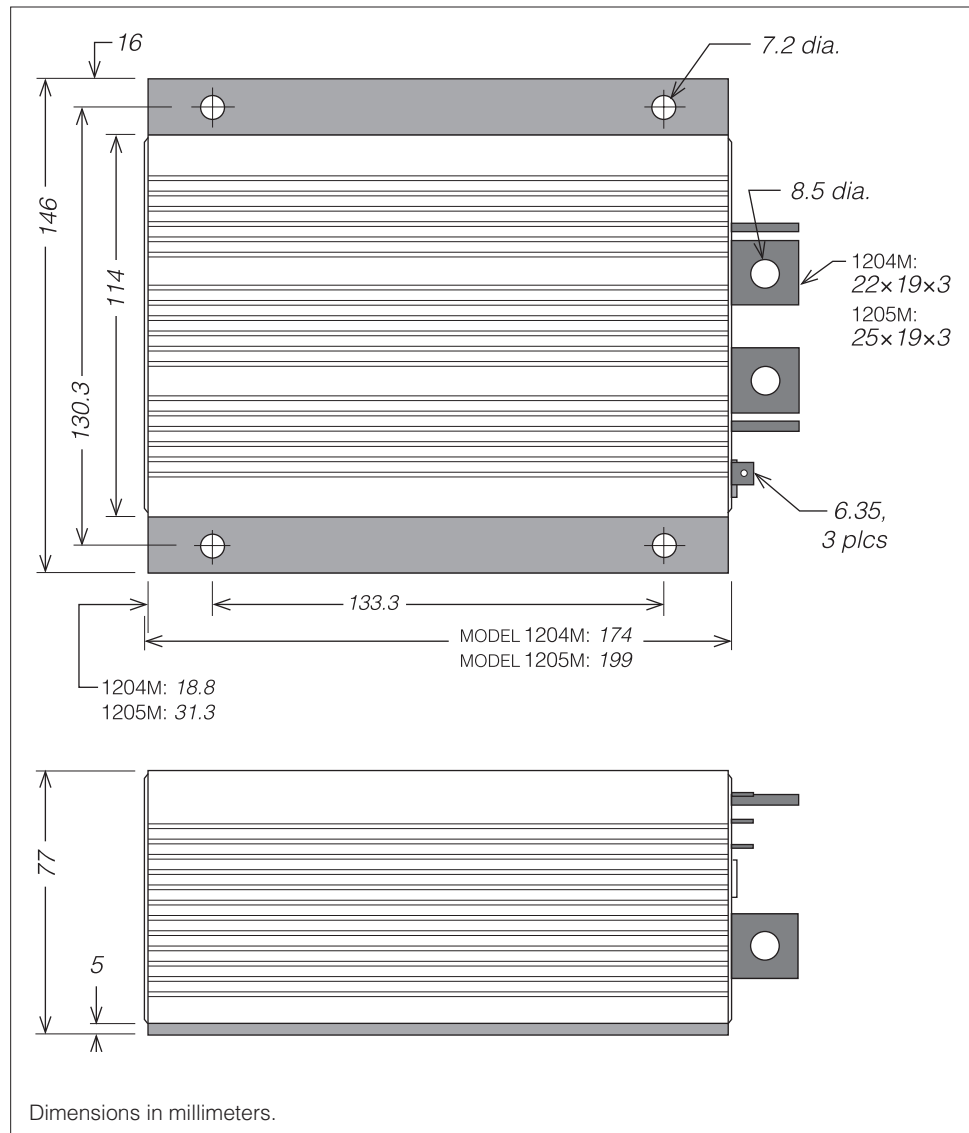

You will need to take steps during the design and development of your end product to ensure that its EMC performance complies with applicable regulations; suggestions are presented in Appendix A.



The 1204M and 1205M controllers contain **ESD-sensitive components**. Use appropriate precautions in connecting, disconnecting, and handling the controller. See installation suggestions in Appendix A for protecting the controller from ESD damage.



**Working on electrical systems is potentially dangerous.** You should protect yourself against uncontrolled operation, high current arcs, and outgassing from lead acid batteries:

**UNCONTROLLED OPERATION** — Some conditions could cause the motor to run out of control. Disconnect the motor or jack up the vehicle and get the drive wheels off the ground before attempting any work on the motor control circuitry.

**HIGH CURRENT ARCS** — Batteries can supply very high power, and arcing can occur if they are short circuited. Always open the battery circuit before working on the motor control circuit. Wear safety glasses, and use properly insulated tools to prevent shorts.

**LEAD ACID BATTERIES** — Charging or discharging generates hydrogen gas, which can build up in and around the batteries. Follow the battery manufacturer's safety recommendations. Wear safety glasses.



## CONNECTIONS

The controller's connectors are all conveniently located on one end:

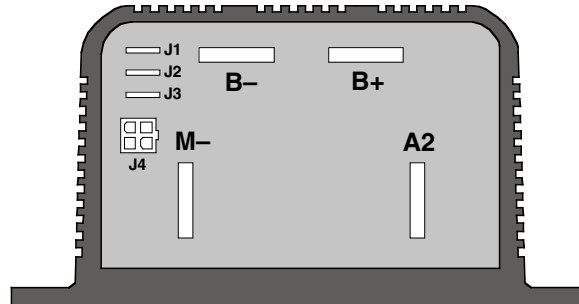

### High current connections

All 1204M/05M controllers have these three high-current busbars: **B+**, **B-**, and **M-**. The models with the plug braking feature (see Specifications, page D-1) also include a fourth busbar: **A2**. The busbars are tin-plated solid copper.

Table 1 High Current Connections	
<b>B+</b>	Positive connection to battery and to motor armature.
<b>B-</b>	Negative connection to battery.
<b>M-</b>	Output to motor field.
<b>A2</b>	Plug diode to motor armature.

Cables used for the battery and motor connections must be heavy enough to carry the high current required. A minimum size of 25 mm<sup>2</sup> (#4 AWG) is recommended.

Connections to the controller busbars should be made with lugs suitable for the cable used, fastened by M8 bolts and nuts. **When tightening the bolts, two opposing wrenches should be used.** Failure to use the double-wrench technique could cause undue strain to be placed on the internal connections, and could also result in cracked seals around the busbars.

### Low current connections

The 1204M/05M controllers have four low-current connections: three 6.35mm push-on terminals (**J1–J3**), and one 4-pin connector (**J4**).

Table 2 Low Current Connections	
<b>J1</b>	Key switch connection.
<b>J2</b>	Connection to wire 1 of 2-wire rheostat.
<b>J3</b>	Connection to wire 2 of 2-wire rheostat, or voltage throttle input.
<b>J4</b>	4-pin connector, for programmer or external Status LED.

For the control wiring, 0.75 mm<sup>2</sup> (#18 AWG) vinyl insulated stranded wire is recommended.

The mating connector for **J4** is a 4-pin Molex Mini-fit Jr. or equivalent. Either an external Status LED or a 1311/1314 programmer can be connected to J4. The pinout is as follows.

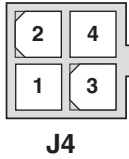

PIN	PROGRAMMER	STATUS LED
<b>J4-1</b>	Data input from programmer (Rx).	Status LED enable.
<b>J4-2</b>	Ground.	Ground.
<b>J4-3</b>	Data output to programmer (Tx).	Status LED output.
<b>J4-4</b>	+15 V.	+15 V.

Note: When J4 is used for a Status LED, a jumper must be added between pins J4-1 and J4-4 as shown in the basic wiring diagram (Figure 3).

## CONTROLLER WIRING: BASIC CONFIGURATION

A basic wiring diagram for the 1204M/05M controller is shown in Figure 3. The throttle shown in the diagram is a 2-wire potentiometer; voltage throttles can also be used. (For pump operation, see Figure 9 on page 12).

Wired this way, the vehicle will plug brake if the direction is changed with the vehicle moving and the throttle applied. Reversing is accomplished via two single-pole, double-throw (2×SPDT) contactors. Coil suppression diodes should be used on the main and forward/reverse contactors.

### KSI Wiring

The keyswitch input (KSI) circuit includes input from the keyswitch and from the various interlocks. The controller KSI is used to turn the controller on and off. KSI is turned on by connecting it to battery B+. Any positive voltage greater than about 16 volts will turn on the controller, but usually the full vehicle battery voltage is used. KSI draws up to 130 mA with the programmer connected, and up to 60 mA without the programmer.

In its simplest form, KSI is operated by a keyswitch that turns the vehicle off and prevents unauthorized use. The keyswitch should also turn off

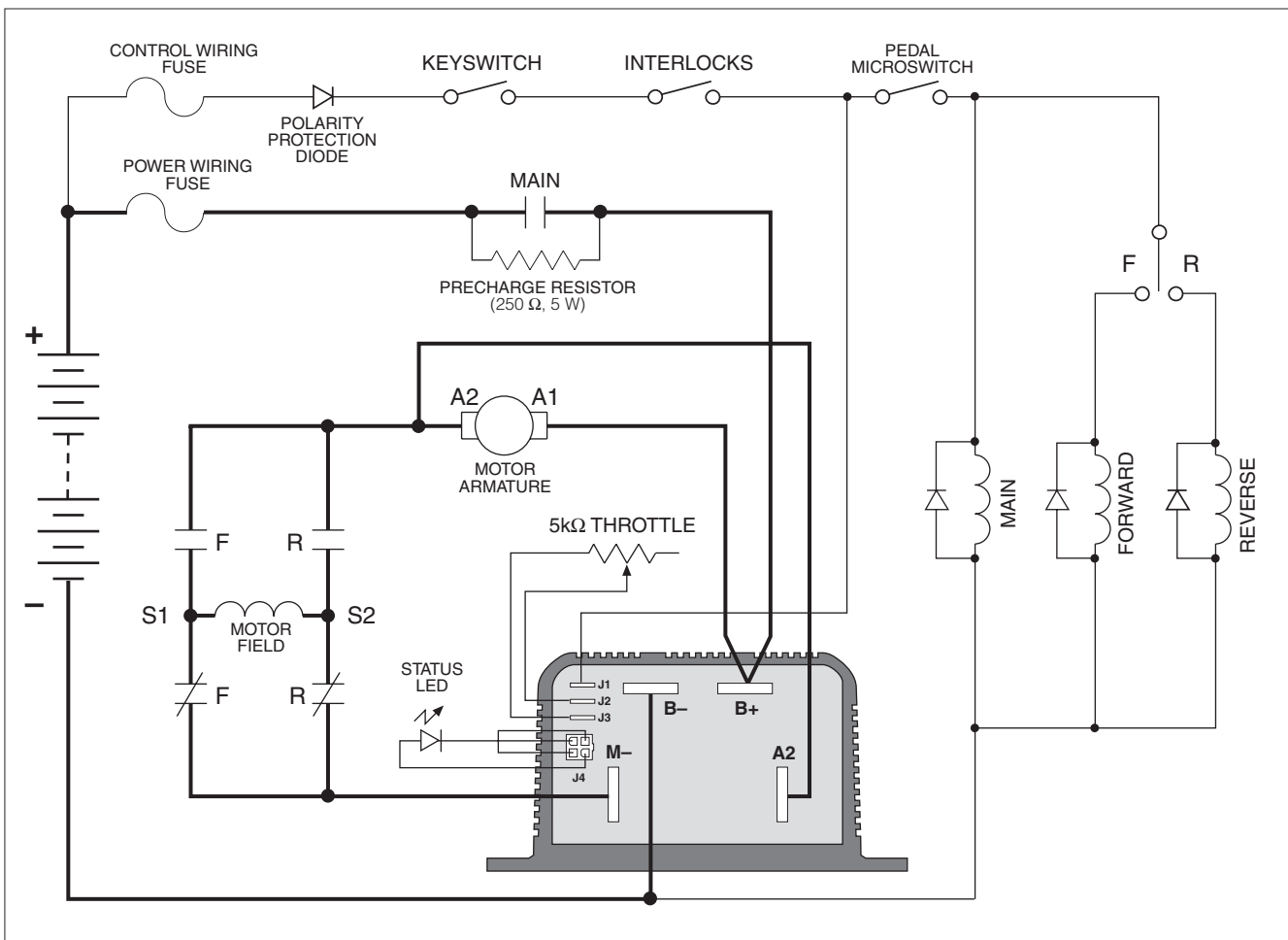

**Fig. 3** Basic wiring diagram, Curtis 1204M/05M motor controller.

the main contactor and the forward/reverse contactors. This will act as a safety feature by removing power from the motor control system when the keyswitch is turned off.

Interlocks (seat switches, battery charger interlocks, etc.) should be wired in series so that they turn off the controller KSI and the contactors.

### Forward/Reverse Wiring

With 1204M/05M controllers, **it is essential that the field be reversed and that the armature be connected directly to the controller's B+ and A2 terminals, because the plug diode inside is connected to these terminals;** this is the wiring shown in Figure 3. Some vehicles, especially those previously using older, resistor-type controllers, may reverse the motor armature rather than the field winding. Be careful if you are replacing this type of controller.

#### Plug braking

The forward/reverse wiring shown in Figure 3 provides plug braking. The forward/reverse switch should be in the positive feed to the contactor coils, so that they can be turned off by the keyswitch and any interlocks. The coil of one contactor or the other is energized to select the direction desired.

#### Freewheeling (wiring to inhibit plug braking)

If plug braking is not desired, the vehicle can be wired so that moving the forward/reverse switch through neutral causes the vehicle to freewheel as long as the throttle is applied. Plug braking can be reactivated during freewheeling by releasing the throttle and reapplying it. The HPD option must be enabled (programmed On) in order for this arrangement to work.

As shown in Figure 4, another set of contacts is added on the forward/reverse switch. Therefore, a double-pole, double-throw (DPDT) center-off switch must be used for this setup. A “hesitation switch” is recommended, to ensure the switch is in neutral long enough to actuate HPD and inhibit plug braking.

**Fig. 4** Wiring to inhibit plug braking, in order to allow freewheeling.

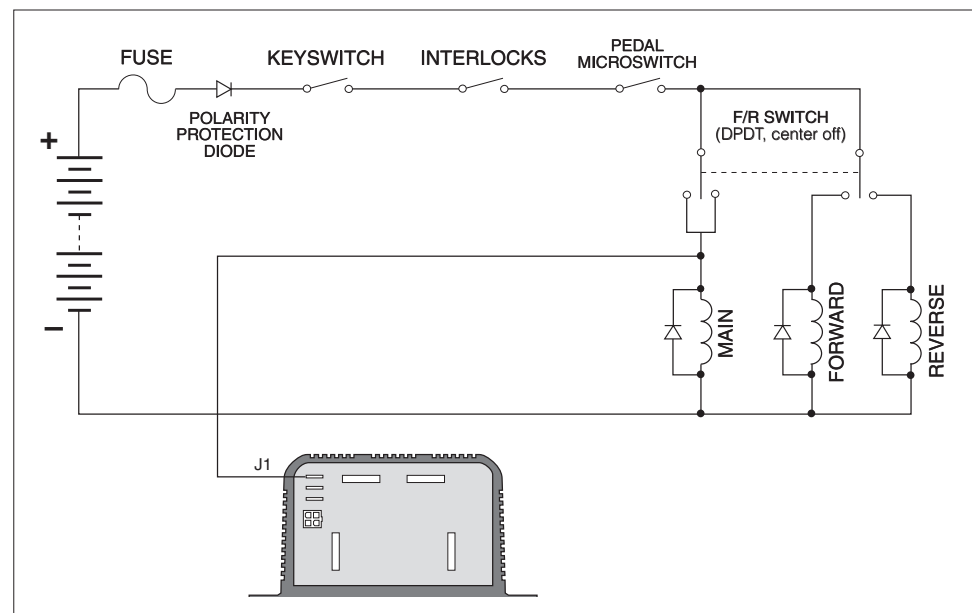

Wiring for mechanical reversing switch (golf car type)

As shown in Figure 5, this type of switch mechanically interchanges the two motor field cables by rotating a movable contact bar. The configuration shown is typical; many variations are in use.

**Fig. 5** Wiring for reversing with a mechanical F/R switch arm..

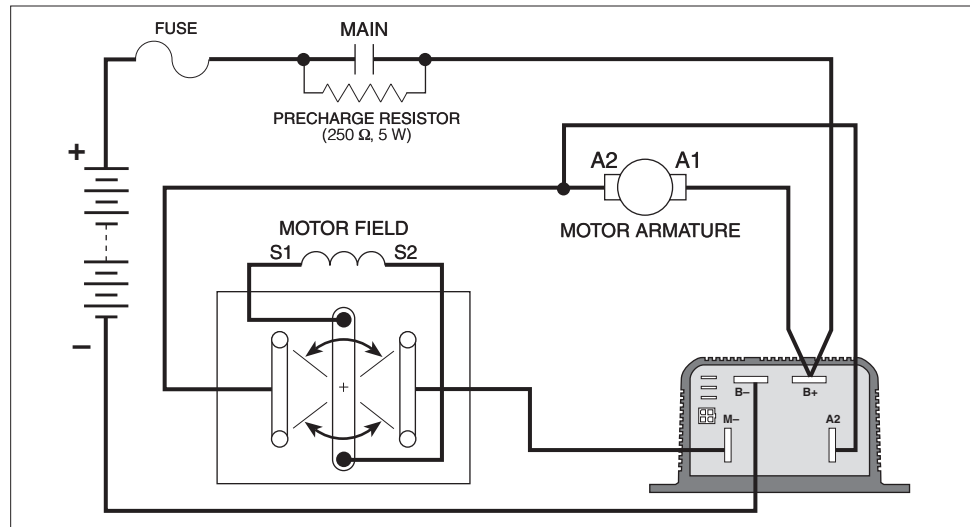

### Throttle Wiring

Three types of throttle can be used with 1204M/05M controllers: Type 0, which is a 0–5k $\Omega$  two-wire rheostat; Type 1, a 5k $\Omega$ –0 2-wire rheostat; and Type 3, a voltage throttle.

*Throttle Type 0*

Wiring for Type 0 throttles is simple: just connect the two wires to the J2 and J3 push-on terminals; it doesn't matter which wire goes on which terminal. With Type 0 throttles, resistance increases as the applied throttle is increased.

**Fig. 6** Wiring for Type 0 throttles.

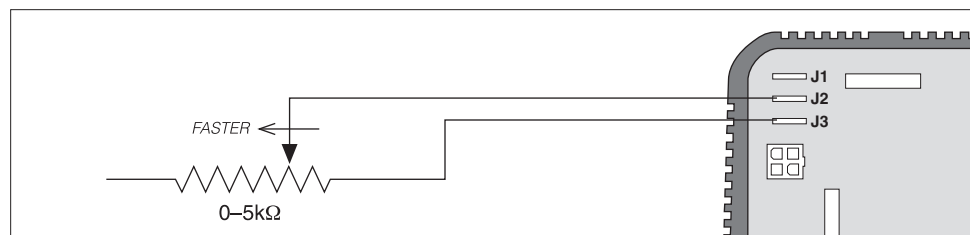

Mechanical potboxes and footpedals are Type 0 throttles. It doesn't matter which wire goes on which terminal, and the wires can be extended as required.

Some potboxes have a built-in microswitch, eliminating the need to install a separate pedal-actuated microswitch. It is important that a pedal microswitch be included in the circuit as shown in Figure 3 to allow the microcontroller a few milliseconds to boot up, run diagnostics and safety checks, and then be ready in standby before receiving the throttle signal.

A potbox makes it easy to retain the vehicle's original cable throttle pedal. Curtis and various third-party vendors also offer self-contained footpedal units that eliminate the need for fabricating and installing a pedal-potbox linkage.

Any potbox that can provide a nominal 0–5k $\Omega$  output will work as a Type 0 throttle input.

If a potbox is used, it must be mounted so as to allow connection between the potbox lever arm and the vehicle accelerator linkage. Use of a second return spring on the pedal, in addition to the potbox return spring, is required to prevent an uncontrollable full-on throttle input (which could happen if there was a single spring, and it broke). If the self-contained potbox spring is insufficient to return the pedal by itself, two additional pedal return springs must be used.

It is also required that the accelerator pedal hit a mechanical stop at its full-on position just before ( $\approx 1$  mm) the potbox lever hits its own full-on stop. This mechanical stop will prevent the potbox lever arm from bending if undue force is put on the pedal. Protection of the potbox from water and dirt will help avoid problems of corrosion and electrical leakage.

After the potbox has been mounted, operation of the pot can be tested by measuring the resistance between the two wires with an ohmmeter. With the pedal not applied, the resistance should be less than 50 ohms. As the pedal is applied, the resistance should rise smoothly until it reaches a value between 4500 and 5500 ohms. Values below 4500 ohms may cause a reduction in efficiency and top speed; however, you still can get top speed by lowering the Throttle Max setting. Values above 7500 ohms indicate a defective potbox, and will cause controller shutdown.

#### Throttle Type 1

Wiring for Type 1 throttles is the same as for Type 0 throttles; again, it doesn't matter which wire goes on which terminal. With Type 1 throttles, resistance is in an inverse relationship to applied throttle; that is, resistance decreases as applied throttle is increased.

**Fig. 7** Wiring for Type 1 throttles.

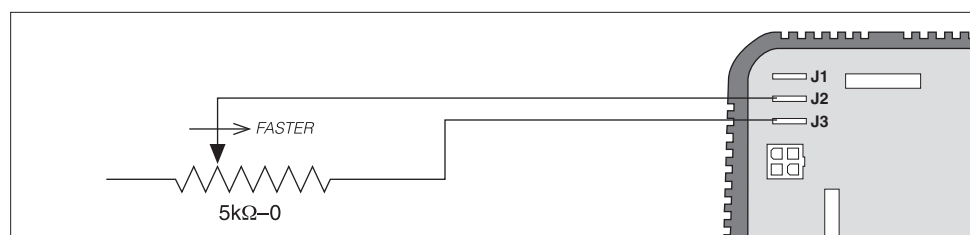

#### Throttle Type 2

With Type 2 throttles, the controller looks for a voltage signal at J3. Zero throttle request corresponds to 0 V and full throttle request to 5 V. A variety of devices can be used with this throttle input type, including voltage sources, current sources, and electronic throttles. The wiring for each is slightly different, as shown in Figure 8, and they have varying levels of throttle fault protection.

When a voltage source is used as a throttle, it is the responsibility of the OEM to provide appropriate throttle fault detection. For ground-referenced

**Fig. 8** *Wiring for Type 2 throttles.*

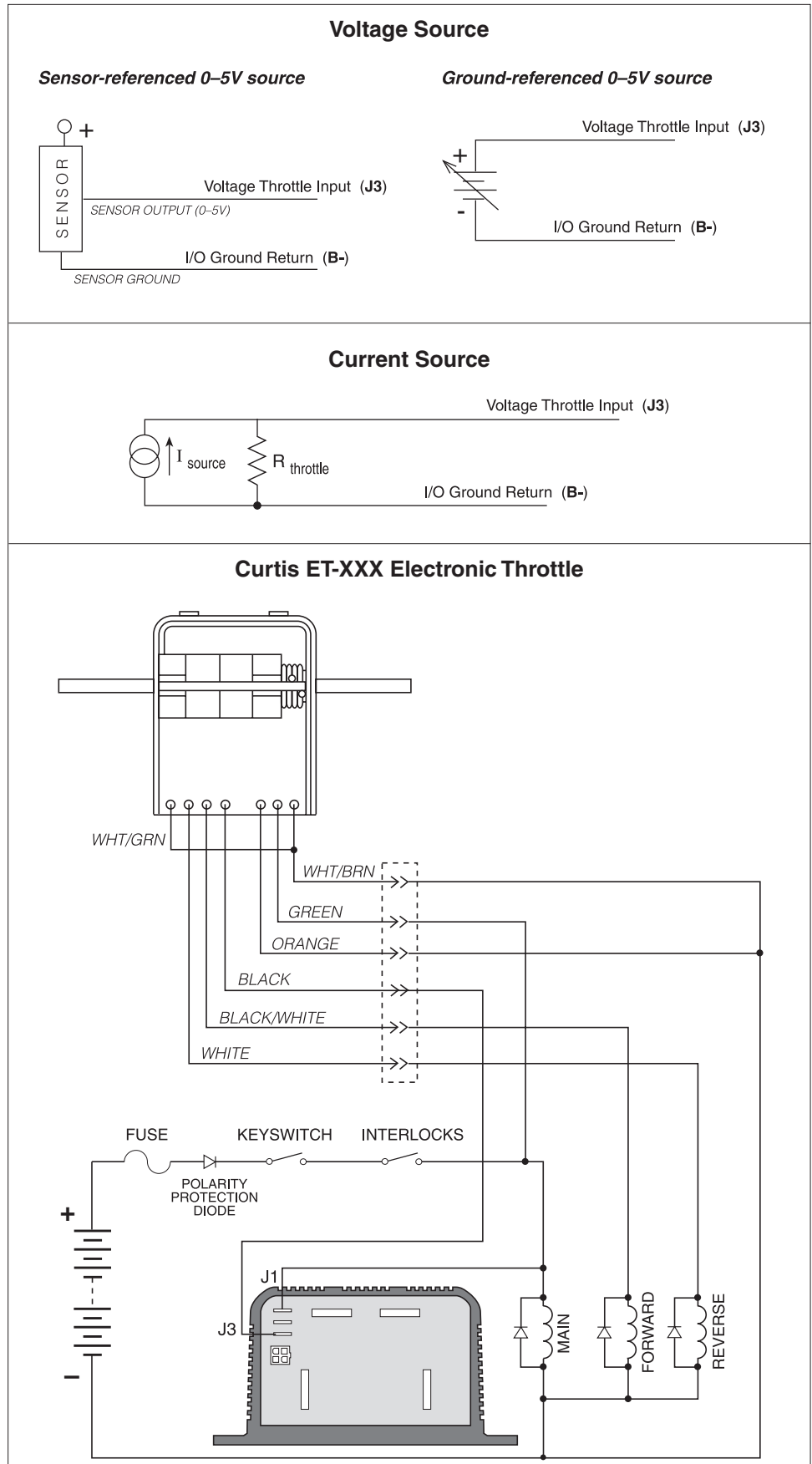

0–5V throttles, the controller will detect open breaks in the wiper input but cannot provide full throttle fault protection.

To use a current source as a throttle, a resistor must be added to the circuit to convert the current source value to a voltage; the resistor should be sized to provide a 0–5V signal variation over the full current range. It is the responsibility of the OEM to provide appropriate throttle fault detection.

The Curtis ET-XXX electronic throttle contains no built-in fault detection, and the controller will detect only open wiper faults. It is the responsibility of the OEM to provide any additional throttle fault detection necessary. For wiring other electronic throttles, consult the instructions that are provided with the throttle.

There are many electronic footpedals on the market; for wiring, consult the instructions that are provided with the footpedal.

### Basic Wiring Configuration for Pump Applications

The 1204M/05M controller models with only three busbars are appropriate for use with pump motors, wired as shown in Figure 9.

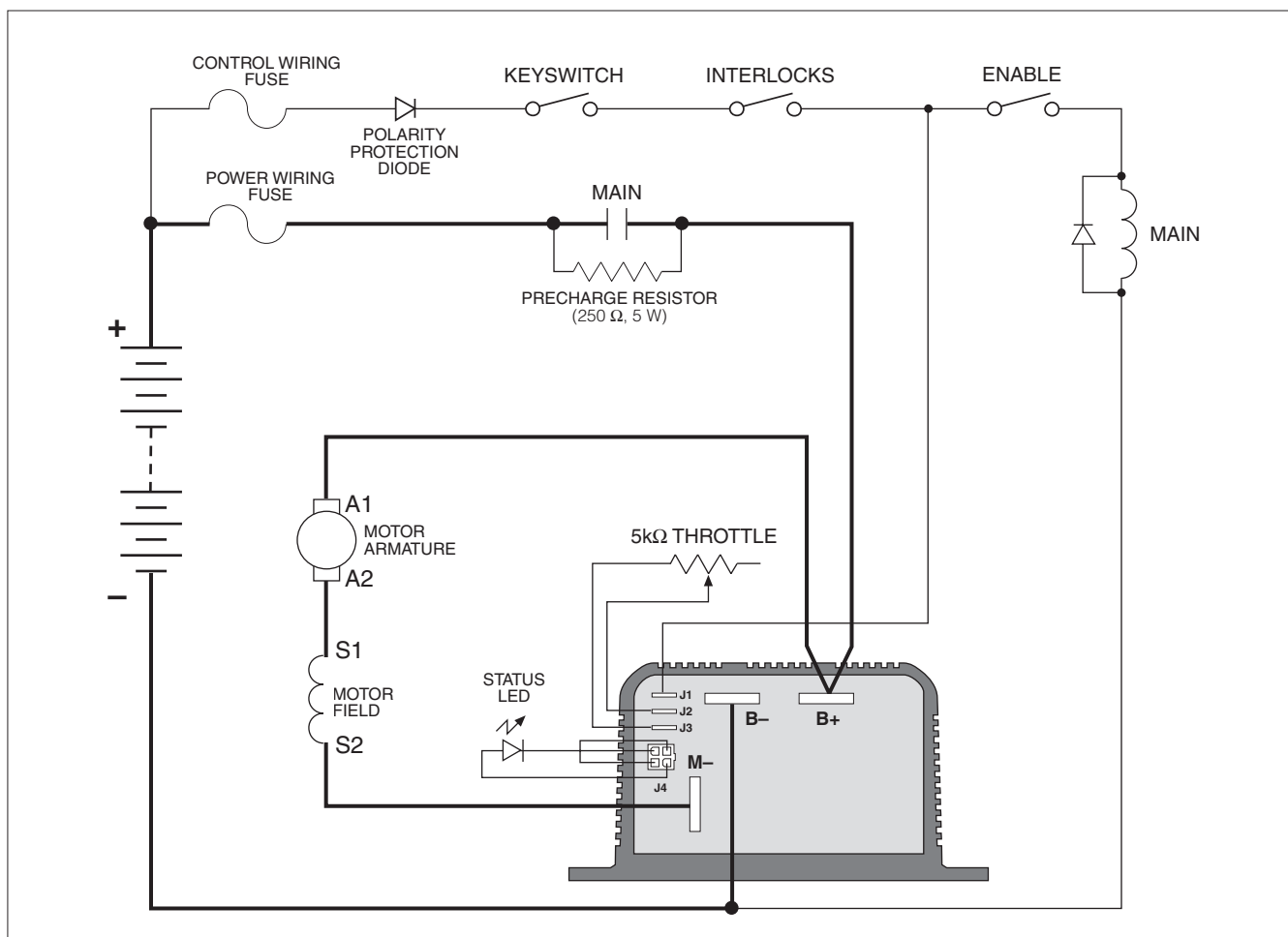

**Fig. 9** Basic wiring diagram, Curtis 1204M/05M motor controller—for pump applications.



## INSTALLATION CHECKOUT

Carefully complete the following checkout procedure before operating the vehicle. If a step does not test correctly, refer to Section 5: Diagnostics and Troubleshooting.



*Put the vehicle up on blocks to get the drive wheels off the ground before beginning these tests.*

*Don't let anyone stand in front of or behind the vehicle during the checkout.*

*Make sure the keyswitch is off and the vehicle is in neutral before beginning.*

*Wear safety glasses and use well-insulated tools.*

- A. Connect the battery. Use a voltmeter to verify that the proper voltage and polarity appears at the battery B+ and B- terminals.
- B. Check the voltage at the controller B+ and B- busbars. If your system has a precharge resistor in parallel with the main contactor, you should see approximately 90% of the full battery voltage. If your system does not have a resistor, temporarily connect one (100 to 200 ohms, 5 watts, or a 100 watt light bulb). The voltage at the controller should rise to approximately 90% of the full battery voltage.
- C. If "A" and "B" do not check out, troubleshoot the wiring connections. **Do not turn on the keyswitch until the trouble is corrected and "A" and "B" check out.**
- D. With the forward/reverse switch in neutral, turn on the keyswitch. If the motor runs without the throttle being applied, turn the keyswitch off and recheck the wiring. If the motor does **not** run without the throttle applied, proceed with the checkout. Select a direction and slowly apply the throttle; the motor should now respond.
- E. Look to see which direction the wheels are turning. If the wheels are going the wrong way, turn everything off and interchange the motor field connections.
- F. If you have HPD, check it next. Turn off the keyswitch and direction switch. Apply the throttle, turn the keyswitch on, and then select a direction. The motor should not run. Release the throttle and re-apply it — the motor should now run. If the motor runs before you release the throttle, recheck the wiring.

G. Take the vehicle down off the blocks and drive it in a clear area. It should have smooth acceleration and good top speed.

H. On vehicles that are intended to plug brake, test the plug braking by driving forward at moderate speed and shifting into reverse without letting up on the throttle. The vehicle should smoothly brake to a stop and accelerate in reverse.

I. On vehicles that are intended to have plug braking inhibited, verify that the maneuver in “H” produces freewheel coasting.

# 3

## PROGRAMMABLE PARAMETERS

The 1204M/1205M controllers have a number of parameters that can be adjusted using a Curtis programming device. These programmable parameters allow the vehicle's performance to be customized to fit the needs of specific applications.

The controller's 16 programmable parameters are displayed on the programmer as a list. The parameters are presented in the following descriptions in the same order as in the display, grouped into these categories:

### *Basic Setup*

Voltage  
Current Limit  
Variable Plug  
HPD

### *Speed and Acceleration*

Max Speed  
Accel Rate  
Quick Start

### *Throttle Input*

Throttle Type  
Throttle Deadband  
Throttle Max  
Throttle Map

### *Undervoltage*

Undervoltage Cutback  
Undervoltage Cutback Rate  
Undervoltage Cutoff

### *Other Parameters*

Contact Protection  
Boost

The individual parameters are presented as follows in the menu charts:

Parameter name as it appears in the programmer display ↓	Allowable range in the programmer's units ↓	Description of the parameter's function and, where applicable, suggestions for setting it ↓
<b>Max Speed</b>	0–100 %	Defines the maximum motor speed at full throttle, as % PWM.

BASIC SETUP PARAMETERS		
PARAMETER	ALLOWABLE RANGE	DESCRIPTION
<b>Voltage</b>	36V / 48V	Each controller has two available battery voltage settings. For all 1204M controller models and the 1205M-5601 and 1205M-5602 controllers, voltage can be set to either 36 volts or 48 volts.
	60V / 72V	For 1205M-6B401 and 1205M-6B402 controllers, voltage can be set to either 60 volts or 72 volts.  Set this parameter to match the battery pack of your vehicle.
<b>Current Limit</b>	<i>see description</i>	The main current limit can be programmed up to the controller's 1-minute or 2-minute current rating (see specs on page D-1). The allowable ranges are: 125–275A    1204M-5201 and 1204M-5202 (in 50A increments) 175–325A    1204M-5301 (in 50A increments) 250–500A    1205M-5601 and 1205M-5602 (in 5A increments) 150–400A    1205M-6B401 and 1205M-6B402 (in 5A increments).
<b>Variable Plug</b>	On/Off	Plug braking occurs when the opposite direction is selected with the forward/reverse switch without releasing the throttle. The vehicle brakes smoothly to a stop and then accelerates in the other direction. When the Variable Plug parameter is set to Off, the plug braking current remains at a fixed factory-set level throughout plug braking. When set to On, the amount of plug braking current is determined by the amount of throttle being applied during plug braking.
<b>HPD</b>	On/Off	By preventing the vehicle from being turned on with the throttle applied, the HPD feature ensures the vehicle starts smoothly and safely. To start, the controller must receive an input to KSI before receiving a throttle input. In addition to providing routine smooth starts, HPD also protects against accidental sudden starts if problems in the linkage (such as bent parts or a broken return spring) give a throttle input signal to the controller even with the throttle released. When programmed Off, the HPD feature is not enabled. When programmed On, the HPD feature is enabled. This is required for full throttle protection.

SPEED AND ACCELERATION PARAMETERS		
PARAMETER	ALLOWABLE RANGE	DESCRIPTION
<b>Max Speed</b>	0–100 %	Defines the maximum requested motor speed at full throttle, as % PWM. Partially-applied throttle is scaled proportionately; e.g., 40% applied throttle corresponds to a request for 40% of the programmed Max Speed value. Example: if Max Speed is set to 80%, a 40% applied throttle corresponds to a 32% request ( $0.80 * 0.40 = 0.32$ ).
<b>Accel Rate</b>	0.2–3.0 sec	The Accel Rate defines the time it takes the controller to accelerate from 0% output to 100% output when full throttle is applied. Larger values represent a longer acceleration time and therefore a gentler start. For faster starts, adjust the Accel Rate to a smaller value.
<b>Quick Start</b>	0.2–3.0 sec	When the throttle is moved from zero rapidly, the quick start feature is activated. The Quick Start acceleration rate then replaces the normal acceleration rate (as set by the Accel Rate parameter). The Quick Start parameter can only be set to values smaller (faster) than the programmed Accel Rate.

THROTTLE INPUT PARAMETERS		
PARAMETER	ALLOWABLE RANGE	DESCRIPTION
<b>Throttle Type</b>	0–2	<p>The 1204M/05M controller accepts a variety of throttle inputs. The Throttle Type parameter can be programmed as follows:</p> <ul style="list-style-type: none"> <li>0 2-wire rheostat, 0–5k<math>\Omega</math> input</li> <li>1 2-wire rheostat, 5k<math>\Omega</math>–0 input</li> <li>2 single-ended 0–5V input.</li> </ul>
<b>Throttle Deadband</b>	5–30 %	<p>The Throttle Deadband parameter defines the neutral deadband as a percentage of the full throttle range. Increasing the Throttle Deadband setting will increase the neutral range. This parameter is especially useful with throttle assemblies that do not reliably return to a well-defined neutral point, because it allows the deadband to be defined wide enough to ensure that the controller goes into neutral when the throttle mechanism is released.</p>
<b>Throttle Max</b>	60–100 %	<p>The Throttle Max parameter defines the percentage of throttle movement at which 100% output is requested. Decreasing the Throttle Max setting reduces the full stroke necessary to produce full controller output. This parameter allows reduced-range throttle assemblies to be accommodated.</p>
<b>Throttle Map</b>	20–80 %	<p>The Throttle Map parameter modifies the vehicle's response to the throttle input. Setting Throttle Map at 50% provides a linear output response to throttle position. Values below 50% reduce the controller output at low throttle settings, providing enhanced slow speed maneuverability. Values above 50% give the vehicle a faster, more responsive feel at low throttle settings.</p> <p>The Throttle Map value is the controller output at half throttle, as a percentage of the Max Speed. Half throttle is the midpoint of the throttle's active range, which is the range from zero output (at the Deadband setting) to 100% output (at the Throttle Max setting).</p>



Note: All three throttle adjustment parameters—Deadband, Max, and Map—condition the throttle command, as shown in Figure 10.

**Fig. 10** *Effect of throttle adjustment parameters.*

*In the examples shown in this figure,*

*Deadband = 10%*  
*Max = 80%.*

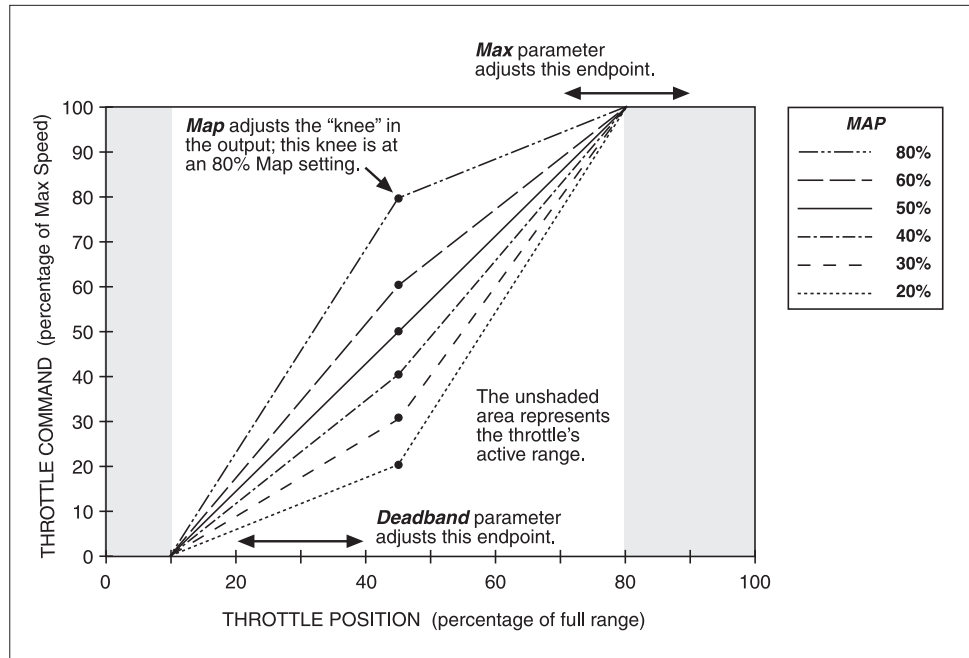

<b>UNDERVOLTAGE PARAMETERS</b>		
PARAMETER	ALLOWABLE RANGE	DESCRIPTION
<b>Undervoltage Cutback</b>	<i>see description</i>	<p>The controller's circuitry requires a minimum battery voltage to function properly. When battery voltage drops, reducing the controller's output to the motor allows the battery to recover. The Undervoltage Cutback parameter sets the threshold voltage below which controller output will start to be reduced.</p> <p>The allowable ranges depend on battery size, as follows.</p> <p style="margin-left: 40px;">36V battery: 25–36 V                      48V battery: 33–48 V                      60V battery: 40–60 V                      72V battery: 50–72 V.</p> <p>Adjustments can be made in 1V increments.</p>
<b>Undervoltage Cutback Rate</b>	0–20	<p>The Undervoltage Cutback Rate determines how quickly the controller output will be reduced when battery voltage falls below the programmed Undervoltage Cutback threshold. Larger values represent faster reduction of controller output.</p>
<b>Undervoltage Cutoff</b>	<i>see description</i>	<p>The Undervoltage Cutoff parameter sets the voltage at which controller output will be cut off completely.</p> <p>The allowable ranges depend on battery size, as follows.</p> <p style="margin-left: 40px;">36V battery: 24–36 V                      48V battery: 32–48 V                      60V battery: 39–60 V                      72V battery: 48–72 V.</p> <p>Adjustments can be made in 1V increments.</p>



OTHER PARAMETERS		
PARAMETER	ALLOWABLE RANGE	DESCRIPTION
<b>Contactor Protection</b>	On/Off	<p>The Contactor Protection parameter can be used to protect the tips of the F/R contactors and main contactor from possible damage due to high current arcs.</p> <p>If the Contactor Protection parameter is programmed On, when the controller detects the throttle is released (within the throttle deadband) it will immediately cut off the PWM output, and because the current is cut off quickly the contactor tips will be opened with no high current arcs. Similarly, when a F/R contactor is open, the controller will lock the PWM output so that when the contactor starts to close again, there is no current on the tips.</p> <p>If programmed Off, this protection is lost. However, the PWM will decrease at the set deceleration rate instead of abruptly, resulting in a smoother stop—which may be desired in some applications.</p>
<b>Boost</b>	On/Off	<p>In situations where the controller detects that the motor is about to stall, the boost feature provides a short burst of extra torque by briefly applying a current higher than the rated current. This can be useful for occasionally getting the vehicle out of a pothole or over an obstacle.</p> <p>Setting the Boost parameter On enables the boost feature.</p> <p>If the Boost parameter is set to Off, the controller's output is limited to its rated current.</p>

## 4

## MONITOR MENU

Through its Monitor menu, the programmer provides access to real-time data during vehicle operation. This information is helpful during diagnostics and troubleshooting, and also while adjusting programmable parameters.

MONITOR MENU		
VARIABLE	DISPLAY UNITS	DESCRIPTION
<b>Heatsink Temp</b>	°C	Heatsink temperature.
<b>Cap Voltage</b>	V	Voltage of controller's internal capacitor bank at B+ busbar.
<b>Battery Voltage</b>	V	Battery voltage.
<b>Motor Voltage</b>	V	Voltage between controller's B+ and M- busbars.
<b>Throttle</b>	%	Throttle request
<b>Duty Cycle</b>	%	Controller's PWM output, as percentage of programmed Max Speed.
<b>Motor Open</b>	On/Off	Status of motor connection.
<b>A2 Voltage</b>	V	Voltage on controller's A2 busbar.
<b>Plug Braking</b>	On/Off	Plug braking feature on or off.

## 5















## DIAGNOSTICS AND TROUBLESHOOTING

The 1204M/05M controller detects a wide variety of faults or error conditions. Fault information can be obtained in either of two ways: (1) by observing the fault codes issued by the external Status LEDs or (2) by reading the display on a programmer. Because the programmer uses the same connector as the Status LED, only one of these ways can be used at any given time.

## LED DIAGNOSTICS

During normal operation, with no faults present, the Status LED flashes steadily. If the controller detects a fault, a 2-digit fault code is flashed until the fault is corrected. For example, code “4,1”—undervoltage cutback—appears as:

□□□□ □	□□□□ □	□□□□ □
( 4 , 1 )	( 4 , 1 )	( 4 , 1 )

LED CODES	EXPLANATION
<i>LED off</i> 	no power or defective controller
<i>solid on</i> 	controller or microprocessor fault
0,1 	controller operational; no known faults
1,1 	EEPROM fault
1,2 	MOSFET short fault
1,3 	motor short fault
2,1 	undervoltage cutoff
2,3 	HPD sequencing error
2,4 	throttle fault
3,4 	main contactor missing or did not close (DNC)
4,1 	undervoltage cutback
4,2 	overvoltage fault
4,3 	cutback, due to over-/under-temperature
4,4 	cutoff, due to severe overtemperature(>120°C)

Note: Only one fault is indicated at a time. Faults are not queued up.

The numerical codes are listed in the troubleshooting chart (Table 5), which also lists effects, clear conditions, and possible causes for each fault.

## PROGRAMMER DIAGNOSTICS

The programmer's Faults/Diagnostics menu displays the faults that are currently set, by name. The programmer's Monitor menu displays various readouts that can be helpful during diagnostics; see Section 4.

For example, in the event of an undervoltage cutback fault, the words **Undervoltage Cutback** will be displayed in the Faults/Diagnostics menu. The real-time battery voltage is displayed in the Monitor menu ("Battery Voltage").

The programmer also can display a history of all the faults that have been set since the history log was last cleared.

## TROUBLESHOOTING

The detection of a fault causes the controller to operate in a manner that is safe in the presence of that fault. Depending on the severity of the fault, the response can range from reducing current to complete shutdown.

The troubleshooting chart, Table 5, provides the following information on all the controller faults:

- fault code
- fault name as displayed on the programmer's LCD
- the effect of the fault
- fault clear conditions
- possible causes of the fault.

Some faults can be self-cleared; for example, an undervoltage fault will clear when the battery voltage returns to an acceptable level. Whenever a fault is encountered and no wiring or vehicle fault can be found, shut off KSI and turn it back on to see if the fault clears. If not, shut off KSI and remove the J-1, J-2, and J-3 connectors. Check the connectors for corrosion or damage, clean them if necessary, and re-insert them.

**Table 5 TROUBLESHOOTING CHART**

LED CODE	PROGRAMMER LCD DISPLAY	EFFECT OF FAULT	RECOVERY	POSSIBLE CAUSE
1,1	EEPROM Fault	PWM output disabled.	Adjust any parameter with programmer.	1. EEPROM data lost or damaged. 2. EEPROM checksum error.
1,2	MOSFET Short Fault	PWM output disabled.	Remove fault & cycle KSI.	1. MOSFET shorted. 2. Controller defective.
1,3	Motor Short Fault	PWM output disabled.	Remove fault & cycle KSI.	1. Motor shorted.
2,1	Undervoltage Cutoff	PWM output disabled.	Battery voltage rises above Undervoltage Cutoff threshold.	1. Battery voltage below the programmed Undervoltage Cutoff threshold.
2,3	HPD	PWM output disabled.	Release throttle.	1. Applied throttle input >20% when KSI is turned on. 2. Applied throttle input >20% after clearing throttle fault.
2,4	Throttle Fault	PWM output disabled.	Throttle input signal within allowable limits.	1. Throttle input wire open or shorted. 2. Defective throttle. 3. Wrong Throttle Type selected.
3,4	Main Contactor DNC	PWM output disabled.	Voltage difference between KSI and B+ busbar <5 V.	1. Main contactor did not close (DNC).
4,1	Undervoltage Cutback	Output current reduced.	Battery voltage rises above Undervoltage Cutback threshold.	1. Battery voltage below the programmed Undervoltage Cutback threshold. 2. Corroded battery terminal. 3. Loose battery or controller connection.
4,2	Overvoltage Fault	PWM output disabled.	Battery voltage falls below overvoltage cutoff threshold.	1. Battery voltage >factory-set overvoltage cutoff threshold. 2. Operation with charger attached.
4,3	Thermal Cutback	Output current reduced.	Heatsink temperature between -25°C and factory-set temperature cutback setpoint.	1. Excessive load on motor. 2. Improper mounting of controller. 3. Operation in extreme environments. 4. Thermistor damaged.
4,4	Overtemperature	PWM output disabled.	Heatsink temperature below the factory-set overtemperature limit.	1. Heatsink temperature above the factory-set overtemperature limit.

## 6

## MAINTENANCE

There are no user serviceable parts in the Curtis 1204M/05M controller. **No attempt should be made to open, repair, or otherwise modify the controller.** Doing so may damage the controller and will void the warranty.

It is recommended that the controller and connections be kept clean and dry and that the controller's fault history file be checked and cleared periodically.

## CLEANING

Periodically cleaning the controller exterior will help protect it against corrosion and possible electrical control problems created by dirt, grime, and chemicals that are part of the operating environment and that normally exist in battery powered systems.



**When working around any battery powered system, proper safety precautions should be taken.** These include, but are not limited to: proper training, wearing eye protection, and avoiding loose clothing and jewelry.

Use the following cleaning procedure for routine maintenance. Never use a high pressure washer to clean the controller.

1. Remove power by disconnecting the battery.
2. Discharge the capacitors in the controller by connecting a load (such as a contactor coil) across the controller's **B+** and **B-** terminals.
3. Remove any dirt or corrosion from the power and signal connector areas. The controller should be wiped clean with a moist rag. Dry it before reconnecting the battery.
4. Make sure the connections are tight.

## DIAGNOSTIC HISTORY

The Curtis programming devices can be used to access the controller's fault history file, via the Faults/Diagnostics menu. The programmer will read out all the faults the controller has experienced since the last time the fault history file was cleared. Faults such as contactor faults may be the result of loose wires; contactor wiring should be carefully checked. Faults such as overtemperature may be caused by operator habits or by overloading.

After a problem has been diagnosed and corrected, it is a good idea to clear the fault history file. This allows the controller to accumulate a new file of faults. By checking the new fault history file at a later date, you can readily determine whether the problem was indeed fixed.

## **APPENDIX A**

### **VEHICLE DESIGN CONSIDERATIONS REGARDING ELECTROMAGNETIC COMPATIBILITY (EMC) AND ELECTROSTATIC DISCHARGE (ESD)**

#### **ELECTROMAGNETIC COMPATIBILITY (EMC)**

Electromagnetic compatibility (EMC) encompasses two areas: emissions and immunity. *Emissions* are radio frequency (RF) energy generated by a product. This energy has the potential to interfere with communications systems such as radio, television, cellular phones, dispatching, aircraft, etc. *Immunity* is the ability of a product to operate normally in the presence of RF energy.

EMC is ultimately a system design issue. Part of the EMC performance is designed into or inherent in each component; another part is designed into or inherent in end product characteristics such as shielding, wiring, and layout; and, finally, a portion is a function of the interactions between all these parts. The design techniques presented below can enhance EMC performance in products that use Curtis motor controllers.

##### *Emissions*

Signals with high frequency content can produce significant emissions if connected to a large enough radiating area (created by long wires spaced far apart). Contactor drivers and the motor drive output from Curtis controllers can contribute to RF emissions. Both types of output are pulse width modulated square waves with fast rise and fall times that are rich in harmonics. (Note: contactor drivers that are not modulated will not contribute to emissions.) The impact of these switching waveforms can be minimized by making the wires from the controller to the contactor or motor as short as possible and by placing the wires near each other (bundle contactor wires with Coil Return; bundle motor wires separately).

For applications requiring very low emissions, the solution may involve enclosing the controller, interconnect wires, contactors, and motor together in one shielded box. Emissions can also couple to battery supply leads and throttle circuit wires outside the box, so ferrite beads near the controller may also be required on these unshielded wires in some applications. It is best to keep the noisy signals as far as possible from sensitive wires.

##### *Immunity*

Immunity to radiated electric fields can be improved either by reducing overall circuit sensitivity or by keeping undesired signals away from this circuitry. The controller circuitry itself cannot be made less sensitive, since it must accurately detect and process low level signals from sensors such as the throttle potentiometer. Thus immunity is generally achieved by preventing the external RF energy from coupling into sensitive circuitry. This RF energy can get into the controller circuitry via conducted paths and radiated paths.

Conducted paths are created by the wires connected to the controller. These wires act as antennas and the amount of RF energy coupled into them is generally proportional to their length. The RF voltages and currents induced in each wire are applied to the controller pin to which the wire is connected. Curtis controllers include bypass capacitors on the printed circuit board's throttle wires to reduce the impact of this RF energy on the internal circuitry. In some applications, additional filtering in the form of ferrite beads may also be required on various wires to achieve desired performance levels.

Radiated paths are created when the controller circuitry is immersed in an external field. This coupling can be reduced by placing the controller as far as possible from the noise source or by enclosing the controller in a metal box. Some Curtis controllers are enclosed by a heatsink that also provides shielding around the controller circuitry, while others are partially shielded or unshielded. In some applications, the vehicle designer will need to mount the controller within a shielded box on the end product. The box can be constructed of just about any metal, although steel and aluminum are most commonly used.

Most coated plastics do not provide good shielding because the coatings are not true metals, but rather a mixture of small metal particles in a non-conductive binder. These relatively isolated particles may appear to be good based on a dc resistance measurement but do not provide adequate electron mobility to yield good shielding effectiveness. Electroless plating of plastic will yield a true metal and can thus be effective as an RF shield, but it is usually more expensive than the coatings.

A contiguous metal enclosure without any holes or seams, known as a Faraday cage, provides the best shielding for the given material and frequency. When a hole or holes are added, RF currents flowing on the outside surface of the shield must take a longer path to get around the hole than if the surface was contiguous. As more "bending" is required of these currents, more energy is coupled to the inside surface, and thus the shielding effectiveness is reduced. The reduction in shielding is a function of the longest linear dimension of a hole rather than the area. This concept is often applied where ventilation is necessary, in which case many small holes are preferable to a few larger ones.

Applying this same concept to seams or joints between adjacent pieces or segments of a shielded enclosure, it is important to minimize the open length of these seams. Seam length is the distance between points where good ohmic contact is made. This contact can be provided by solder, welds, or pressure contact. If pressure contact is used, attention must be paid to the corrosion characteristics of the shield material and any corrosion-resistant processes applied to the base material. If the ohmic contact itself is not continuous, the shielding effectiveness can be maximized by making the joints between adjacent pieces overlapping rather than abutted.

The shielding effectiveness of an enclosure is further reduced when a wire passes through a hole in the enclosure; RF energy on the wire from an external field is re-radiated into the interior of the enclosure. This coupling mechanism can be reduced by filtering the wire where it passes through the shield boundary.



Given the safety considerations involved in connecting electrical components to the chassis or frame in battery powered vehicles, such filtering will usually consist of a series inductor (or ferrite bead) rather than a shunt capacitor. If a capacitor is used, it must have a voltage rating and leakage characteristics that will allow the end product to meet applicable safety regulations.

The B+ (and B-, if applicable) wires that supply power to a control panel should be bundled with the other control wires to the panel so that all these wires are routed together. If the wires to the control panel are routed separately, a larger loop area is formed. Larger loop areas produce more efficient antennas which will result in decreased immunity performance.

Keep all low power I/O separate from the motor and battery leads. When this is not possible, cross them at right angles.

## **ELECTROSTATIC DISCHARGE (ESD)**

Curtis motor controllers contain ESD-sensitive components, and it is therefore necessary to protect them from ESD (electrostatic discharge) damage. Most of these control lines have protection for moderate ESD events, but must be protected from damage if higher levels exist in a particular application.

ESD immunity is achieved either by providing sufficient distance between conductors and the ESD source so that a discharge will not occur, or by providing an intentional path for the discharge current such that the circuit is isolated from the electric and magnetic fields produced by the discharge. In general the guidelines presented above for increasing radiated immunity will also provide increased ESD immunity.

It is usually easier to prevent the discharge from occurring than to divert the current path. A fundamental technique for ESD prevention is to provide adequately thick insulation between all metal conductors and the outside environment so that the voltage gradient does not exceed the threshold required for a discharge to occur. If the current diversion approach is used, all exposed metal components must be grounded. The shielded enclosure, if properly grounded, can be used to divert the discharge current; it should be noted that the location of holes and seams can have a significant impact on ESD suppression. If the enclosure is not grounded, the path of the discharge current becomes more complex and less predictable, especially if holes and seams are involved. Some experimentation may be required to optimize the selection and placement of holes, wires, and grounding paths. Careful attention must be paid to the control panel design so that it can tolerate a static discharge.

MOV, transorbs, or other devices can be placed between B- and offending wires, plates, and touch points if ESD shock cannot be otherwise avoided.

## APPENDIX B

### CURTIS WEEE / RoHS STATEMENT, MARCH 2009

#### WEEE

The Directive 2002/96/EC on Waste Electrical and Electronic Equipment (WEEE) was adopted by the European Council and Parliament and the Council of the European Union on January 27, 2003. The aim of the directive was to improve the collection and recycling of WEEE throughout the EU, and to reduce the level of non-recycled waste. The directive was implemented into law by many EU member states during 2005 and 2006. This document provides a general description of Curtis's approach to meeting the requirements of the WEEE legislation.

Note that the directive gave some flexibility to the member states in implementing their individual WEEE regulations, leading to the definition of varying implementation requirements by country. These requirements may involve considerations beyond those reflected in this document. This statement is not intended and shall not be interpreted or construed to be legal advice or to be legally binding on Curtis or any third party.

#### *Commitment*

Curtis is committed to a safe and healthy environment and has been working diligently to ensure its compliance with WEEE legislation. Curtis will comply with WEEE legislation by:

- Designing its equipment with consideration to future dismantling, recovery and recycling requirements;
- Marking its products that fall within the scope of the directive with the required symbol and informing users of their obligation;
- To separate WEEE from general waste and dispose of it through the provided recycling systems;
- Reporting information as required by each member state;
- Facilitating the collection, recycling and disposal of WEEE from private households and other than private households (businesses) as defined by the applicable member state regulation;
- Providing information to treatment centres according to the requirements defined in the local regulation.

#### *WEEE symbol on Curtis products*



The requirement to mark equipment with the WEEE symbol (the crossed-out wheeled bin) went into effect as of August 13, 2005. As of this date, Curtis Instruments began the process of marking all products that fall within scope of this directive with the WEEE symbol, as shown opposite.

#### *Obligations for buyers of electrical and electronic equipment*

As of 13 August 2005, in each EU member state where the WEEE directive has been implemented, disposal of EEE waste other than in accordance with the scheme

is prohibited. Generally, the schemes require collection and recycling of a broad range of EEE products. Certain Curtis products fall within the scope of the directive and the implemented member state regulations. Affected Curtis products that have reached end-of-life must not be disposed as general waste, but instead, put into the collection and recycling system provided in the relevant jurisdiction.

## **RoHS**

For several years now, Curtis has been implementing a rigorous program with the aim of achieving full compliance with the Restrictions on the use of Hazardous Substances (RoHS) Directive, 2002/95/EC.

Curtis has taken all available steps to eliminate the use of the six restricted hazardous substances listed in the directive wherever possible. As a result of the Curtis RoHS program, many of our instrumentation product lines are now fully RoHS compliant.

However, Curtis's electronic motor speed controller products are safety-critical devices, switching very large currents and designed for use in extreme environmental conditions. For these product lines, we have successfully eliminated five out of the six restricted hazardous substances. The single remaining issue preventing full RoHS compliance is the unsuitability of the lead-free solders available to date, due to the well-documented issues such as tin whiskers, and premature failure (compared with leaded solder) due to shock, vibration, and thermal cycling.

Curtis is closely monitoring all RoHS developments globally, and in particular is following the automotive industry's attempts to introduce lead-free solder as a result of the End of Life Vehicle (ELV) Directive, 2003/53/EC. To date, the automotive industry has rejected all lead-free solder pastes due to a significant reduction in reliability compared to leaded soldering.

Curtis firmly believes that the operating environments, safety requirements, and reliability levels required of automotive electronics are directly analogous to that of our speed controller products. As such, Curtis will not be switching to a lead-free solder process until lead-free solder pastes and techniques are available that meet the requirements of the RoHS study groups and ELV Automotive Industry bodies. That is, when all known issues, including that of tin whiskers, are satisfactorily resolved.

At this moment in time, all Curtis motor speed controllers used on industrial vehicle applications are also regarded as exempt under EEE category 9 of the RoHS directive 2002/95/EC. This means there is no requirement at this time for Curtis control systems used on such equipment to comply with the directive. Curtis will work closely with all key customers to ensure that whenever possible, we are in a position to continue the supply of products should these exemptions expire.

## APPENDIX C

### PROGRAMMING DEVICES

Curtis programmers provide programming, diagnostic, and test capabilities for the 1204M/1205M controller. The power for operating the programmer is supplied by the host controller via a 4-pin connector. When the programmer powers up, it gathers information from the controller.

Two types of programming devices are available: the 1314 PC Programming Station and the 1313 handheld programmer. The Programming Station has the advantage of a large, easily read screen; on the other hand, the handheld programmer (with its 45×60mm screen) has the advantage of being more portable and hence convenient for making adjustments in the field.

Both programmers are available in User, Service, Dealer, and OEM versions. Each programmer can perform the actions available at its own level and the levels below that—a User-access programmer can operate at only the User level, whereas an OEM programmer has full access.

#### PC PROGRAMMING STATION (1314)

The Programming Station is an MS-Windows 32-bit application that runs on a standard Windows PC. Instructions for using the Programming Station are included with the software.

#### HANDHELD PROGRAMMER (1313)

The 1313 handheld programmer is functionally equivalent to the PC Programming Station; operating instructions are provided in the 1313 manual. This programmer replaces the 1311, an earlier model with fewer functions.

#### PROGRAMMER FUNCTIONS

Programmer functions include:

**Parameter adjustment** — provides access to the individual programmable parameters.

**Monitoring** — presents real-time values during vehicle operation; these include all inputs and outputs.

**Diagnostics and troubleshooting** — presents diagnostic information, and also a means to clear the fault history file.

**Programming** — allows you to save/restore custom parameter settings files and also to update the system software (not available on the 1311).

**Favorites** — allows you to create shortcuts to your frequently-used adjustable parameters and monitor variables (not available on the 1311).

## APPENDIX D SPECIFICATIONS

**Table D-1 SPECIFICATIONS: 1204M/1205M CONTROLLERS**

Nominal input voltage	36/48 V, 60/72 V
PWM operating frequency	15 kHz
Electrical isolation to heatsink (min.)	36/48V models: 500 V; 60/72V models: 1000 V
KSI input current (no contactors engaged)	<60 mA without programmer; <130 mA with programmer
Logic input current	<1 mA
Status LED output current (max.)	2 mA
Throttle type	2-wire 0–5k $\Omega$ , 2-wire 5k $\Omega$ –0, or 0–5V
Storage ambient temperature range	-40°C to 85°C (-40°F to 185°F)
Operating ambient temp. range	-40°C to 50°C (-40°F to 122°F)
Package environmental rating	ISTA 2A; electronics sealed to IP65
Weight	1204M: 2.3 kg; 1205M: 2.7 kg
Dimensions (L×W×H)	1204M: 174 × 146 × 77 mm 1205M: 199 × 146 × 77 mm
Regulatory compliance	Safety — Designed to the requirements of EN 1175 EMC — Designed to the requirements of EN 12895 and EN 61000.  <i>Note: Regulatory compliance of the complete vehicle system with the controller installed is the responsibility of the OEM.</i>

MODEL NUMBER	NOMINAL BATTERY VOLTAGE (volts)	CURRENT RATING		5 SECOND BOOST CURRENT (amps)	1 HOUR RATING (amps)	OVERVOLTAGE CUTOFF (volts)	PLUG BRAKING: A2 BUSBAR (yes/no)	PLUG CURRENT LIMIT (amps)
		1 MINUTE (amps)	2 MINUTE (amps)					
<b>1204M-5201</b>	36/48		275	350	125	24 (36V) / 32 (48V)	YES	70
<b>1204M-5202</b>	36/48		275	350	125	24 (36V) / 32 (48V)	NO	—
<b>1204M-5301</b>	36/48		325	375	140	24 (36V) / 32 (48V)	YES	80
<b>1205M-5601</b>	36/48	500		600	175	24 (36V) / 32 (48V)	YES	125
<b>1205M-5602</b>	36/48	500		600	175	24 (36V) / 32 (48V)	NO	—
<b>1205M-6B401</b>	60/72	400		500	150	39 (60V) / 48 (72V)	YES	100
<b>1205M-6B402</b>	60/72	400		500	150	39 (60V) / 48 (72V)	NO	—

Note: Current rating tests conducted with the controller mounted to a 3mm×305mm×305mm aluminum plate; continuous 4.8 km/h airflow applied perpendicular to back of plate; ambient air temperature held near 25°C.

